

# OSRAM SFH 7072

## Datasheet

Published by **ams-OSRAM AG**

Tobelbader Strasse 30, 8141 Premstaetten, Austria

Phone +43 3136 500-0

[ams-osram.com](http://ams-osram.com)

© All rights reserved



BIOFY®

# SFH 7072

Biomonitoring Sensor



## Applications

- Health Monitoring (Heart Rate Monitoring, Pulse Oximetry)

## Features

- ESD: 2 kV acc. to ANSI/ESDA/JEDEC JS-001 (HBM, Class 2)
- Multi chip package featuring two green, one red, one infrared emitter and two photodetectors
- Light Barrier to block optical crosstalk
- optimized for strong PPG signal
- Package size: (WxDxH) 7.5 mm x 3.9 mm x 0.9 mm

## Ordering Information

Type  
SFH 7072

Ordering Code  
Q65112A1516

---

## Maximum Ratings

 $T_A = 25\text{ °C}$ 

Parameter	Symbol		Values
Operating temperature range	$T_{op}$	min.	-40 °C
		max.	85 °C
Storage temperature range	$T_{stg}$	min.	-40 °C
		max.	85 °C
ESD withstand voltage acc. to ANSI/ESDA/JEDEC JS-001 - HBM	$V_{ESD}$	max.	2 kV
<b>Green Emitters</b>			
Reverse voltage <sup>5)</sup>	$V_R$	max.	5 V
Forward current	$I_F(DC)$	max.	25 mA
Forward current pulsed $t_p = 5\text{ ms}$ , $D = 0.005$	$I_F\text{ pulse}$	max.	300 mA
<b>Red Emitter</b>			
Reverse voltage <sup>5)</sup>	$V_R$	max.	12 V
Forward current	$I_F(DC)$	max.	40 mA
Forward current pulsed $t_p = 300\text{ }\mu\text{s}$ , $D = 0.005$	$I_F\text{ pulse}$	max.	300 mA
<b>Infrared Emitters</b>			
Reverse voltage <sup>5)</sup>	$V_R$	max.	5 V
Forward current	$I_F(DC)$	max.	60 mA
Forward current pulsed $t_p = 200\text{ }\mu\text{s}$ , $D = 0.005$	$I_F\text{ pulse}$	max.	1 A
<b>Photodiode</b>			
Reverse voltage	$V_R$	max.	16 V

## Characteristics

$T_A = 25\text{ °C}$

Parameter	Symbol		Values
<b>Green Emitter (single emitter)</b>			
Peak wavelength $I_F = 20\text{ mA}$	$\lambda_{\text{peak}}$	typ.	526 nm
Centroid Wavelength <sup>6)</sup> $I_F = 20\text{ mA}$	$\lambda_{\text{centroid}}$	min.	520 nm
		typ.	530 nm
		max.	540 nm
Spectral bandwidth at 50% of $I_{\text{max}}$ $I_F = 20\text{ mA}$	$\Delta\lambda$	typ.	32 nm
Half angle	$\phi$	typ.	$\pm 60\text{ °}$
Rise time $I_F = 100\text{ mA}, t_p = 16\mu\text{s}, R_L = 50\ \Omega$	$t_r$	typ.	60 ns
Fall time $I_F = 100\text{ mA}, t_p = 16\mu\text{s}, R_L = 50\ \Omega$	$t_f$	typ.	60 ns
Forward voltage <sup>7)</sup> $I_F = 20\text{ mA}$	$V_F$	typ.	2.4 V
		max.	2.8 V
Reverse current $V_R = 5\text{ V}$	$I_R$		not designed for reverse operation
Radiant intensity $I_F = 20\text{ mA}, t_p = 20\text{ ms}$	$I_e$	typ.	4.7 mW / sr
Total radiant flux $I_F = 20\text{ mA}, t_p = 20\text{ ms}$	$\Phi_e$	typ.	14 mW
Temperature coefficient of brightness $I_F = 20\text{ mA}, t_p = 20\text{ ms}$	$TC_I$	typ.	-0.35 % / K
Temperature coefficient of wavelength $I_F = 20\text{ mA}, -10\text{ °C} \leq T \leq 100\text{ °C}$	$TC_\lambda$	typ.	0.03 nm / K
Temperature coefficient of voltage $I_F = 20\text{ mA}, -10\text{ °C} \leq T \leq 100\text{ °C}$	$TC_V$	typ.	-3.6 mV / K

## Characteristics

$T_A = 25\text{ °C}$

Parameter	Symbol		Values
<b>Red Emitter</b>			
Peak wavelength $I_F = 20\text{ mA}$	$\lambda_{\text{peak}}$	typ.	660 nm
Centroid Wavelength <sup>6)</sup> $I_F = 20\text{ mA}$	$\lambda_{\text{centroid}}$	min.	652 nm
		typ.	655 nm
		max.	658 nm
Spectral bandwidth at 50% of $I_{\text{max}}$ $I_F = 20\text{ mA}$	$\Delta\lambda$	typ.	17 nm
Half angle	$\phi$	typ.	$\pm 60\text{ °}$
Rise time $I_F = 100\text{ mA}, t_p = 16\mu\text{s}, R_L = 50\ \Omega$	$t_r$	typ.	17 ns
Fall time $I_F = 100\text{ mA}, t_p = 16\mu\text{s}, R_L = 50\ \Omega$	$t_f$	typ.	17 ns
Forward voltage <sup>7)</sup> $I_F = 20\text{ mA}$	$V_F$	typ.	1.9 V
		max.	2.2 V
Reverse current $V_R = 12\text{V}$	$I_R$		not designed for reverse operation
Radiant intensity $I_F = 20\text{ mA}, t_p = 20\text{ ms}$	$I_e$	typ.	5.1 mW / sr
Total radiant flux $I_F = 20\text{ mA}, t_p = 20\text{ ms}$	$\Phi_e$	typ.	16 mW
Temperature coefficient of wavelength $I_F = 20\text{ mA}, -10\text{ °C} \leq T \leq 100\text{ °C}$	$TC_{\lambda}$	typ.	0.18 nm / K

## Characteristics

$T_A = 25\text{ °C}$

Parameter	Symbol		Values
<b>Infrared Emitter</b>			
Peak wavelength $I_F = 20\text{ mA}, t_p = 20\text{ ms}$	$\lambda_{\text{peak}}$	typ.	950 nm
Centroid Wavelength <sup>6)</sup> $I_F = 20\text{ mA}, t_p = 20\text{ ms}$	$\lambda_{\text{centroid}}$	min.	930 nm
		typ.	940 nm
		max.	950 nm
Spectral bandwidth at 50% of $I_{\text{max}}$ $I_F = 20\text{ mA}, t_p = 20\text{ ms}$	$\Delta\lambda$	typ.	42 nm
Half angle	$\phi$	typ.	$\pm 60\text{ °}$
Rise time (10% and 90%) $I_F = 100\text{ mA}, t_p = 16\text{ }\mu\text{s}, R_L = 50\text{ }\Omega$	$t_r$	typ.	16 ns
Fall time (10% and 90%) $I_F = 100\text{ mA}, t_p = 16\text{ }\mu\text{s}, R_L = 50\text{ }\Omega$	$t_f$	typ.	16 ns
Forward voltage <sup>7)</sup> $I_F = 20\text{ mA}, t_p = 20\text{ ms}$	$V_F$	typ.	1.3 V
		max.	1.8 V
Reverse current $V_R = 5\text{ V}$	$I_R$	.	Not designed for reverse operation
Radiant intensity $I_F = 20\text{ mA}, t_p = 20\text{ ms}$	$I_e$	typ..	3.9 mW / sr
Total radiant flux $I_F = 20\text{ mA}, t_p = 20\text{ ms}$	$\Phi_e$	typ.	11 mW
Temperature coefficient brightness $I_F = 20\text{ mA}, t_p = 20\text{ ms}$	$TC_I$	typ.	-0.3 % / K
Temperature coefficient of wavelength $I_F = 20\text{ mA}, t_p = 20\text{ ms}$	$TC_\lambda$	typ.	0.25 nm / K
Temperature coefficient of voltage $I_F = 20\text{ mA}, t_p = 20\text{ ms}$	$TC_V$	typ.	-0.8 mV / K

## Characteristics

$T_A = 25\text{ °C}$

Parameter	Symbol		Values
<b>Broadband Detector</b>			
Wavelength of max. sensitivity	$\lambda_{S\text{ max}}$	typ.	960 nm
Spectral range of sensitivity	$\lambda_{10\%}$	typ.	410 ... 1100 nm
Photocurrent $E_e = 0.1\text{ mW/cm}^2$ , $\lambda = 530\text{ nm}$ , $V_R = 5\text{ V}$	$I_P$	typ.	0.4 $\mu\text{A}$
Photocurrent $E_e = 0.1\text{ mW/cm}^2$ , $\lambda = 655\text{ nm}$ , $V_R = 5\text{ V}$	$I_P$	typ.	0.6 $\mu\text{A}$
Photocurrent $E_e = 0.1\text{ mW/cm}^2$ , $\lambda = 940\text{ nm}$ , $V_R = 5\text{ V}$	$I_P$	typ.	1.1 $\mu\text{A}$
Radiation sensitive area	A	typ.	0.88 mm <sup>2</sup>
Dimensions of radiant sensitive area	L x W	typ.	0.89 x 0.89 mm x mm
Half angle	$\phi$	typ.	$\pm 60\text{ °}$
Dark current $V_R = 5\text{ V}$ , $E = 0$	$I_R$	typ. max.	0.05 nA 10 nA
Open-circuit voltage $E_e = 0.1\text{ mW/cm}^2$ , $\lambda = 530\text{ nm}$	$V_O$	typ.	211 mV
Open-circuit voltage $E_e = 0.1\text{ mW/cm}^2$ , $\lambda = 655\text{ nm}$	$V_O$	typ.	249 mV
Open-circuit voltage $E_e = 0.1\text{ mW/cm}^2$ , $\lambda = 940\text{ nm}$	$V_O$	typ.	266 mV
Short-circuit current $E_e = 0.1\text{ mW/cm}^2$ , $\lambda = 530\text{ nm}$	$I_{sc}$	typ.	0.4 $\mu\text{A}$
Short-circuit current $E_e = 0.1\text{ mW/cm}^2$ , $\lambda = 655\text{ nm}$	$I_{sc}$	typ.	0.6 $\mu\text{A}$
Short-circuit current $E_e = 0.1\text{ mW/cm}^2$ , $\lambda = 940\text{ nm}$	$I_{sc}$	typ.	1.1 $\mu\text{A}$
Rise time $V_R = 5\text{ V}$ , $R_L = 50\ \Omega$ , $\lambda = 940\text{ nm}$	$t_r$	typ.	0.75 $\mu\text{s}$
Fall time $V_R = 5\text{ V}$ , $R_L = 50\ \Omega$ , $\lambda = 940\text{ nm}$	$t_f$	typ.	0.75 $\mu\text{s}$
Forward voltage $I_F = 100\text{ mA}$ , $E = 0$	$V_F$	typ..	1.16 V
Capacitance $V_R = 5\text{ V}$ , $f = 1\text{ MHz}$ , $E = 0$	$C_O$	typ.	4.2 pF



## Characteristics

$T_A = 25\text{ °C}$

Parameter	Symbol		Values
<b>IR-Cut Detector</b>			
Wavelength of max. sensitivity	$\lambda_{S\text{ max}}$	typ.	635 nm
Spectral range of sensitivity	$\lambda_{10\%}$	typ.	402 ... 694 nm
Photocurrent $E_e = 0.1\text{ mW/cm}^2$ , $\lambda = 530\text{ nm}$ , $V_R = 5\text{ V}$	$I_P$	typ.	1.1 $\mu\text{A}$
Radiation sensitive area	A	typ.	3.46 mm <sup>2</sup>
Dimensions of radiant sensitive area	L x W	typ.	1.29 x 2.69 mm x mm
Half angle	$\phi$	typ.	$\pm 57\text{ °}$
Dark current $V_R = 5\text{ V}$ , $E_e = 0$	$I_R$	typ. max.	0.4 nA 2 nA
Open-circuit voltage $E_e = 0.1\text{ mW/cm}^2$ , $\lambda = 530\text{ nm}$	$V_O$	typ.	390 mV
Short-circuit current $E_e = 0.1\text{ mW/cm}^2$ , $\lambda = 530\text{ nm}$	$I_{sc}$	typ.	1.1 $\mu\text{A}$
Rise time $V_R = 5\text{ V}$ , $R_L = 50\ \Omega$ , $\lambda = 530\text{ nm}$	$t_r$	typ.	40 ns
Fall time $V_R = 5\text{ V}$ , $R_L = 50\ \Omega$ , $\lambda = 530\text{ nm}$	$t_f$	typ.	40 ns
Forward voltage $I_F = 10\text{ mA}$ , $E = 0$	$V_F$	typ..	0.84 V
Capacitance $V_R = 5\text{ V}$ , $f = 1\text{ MHz}$ , $E = 0$	$C_0$	typ.	55 pF

### Relative Spectral Emission <sup>1), 2)</sup>

- true green:  $I_{e,rel} = f(\lambda)$ ;  $I_F = 20 \text{ mA}$ ;  $t_p = 20 \text{ ms}$

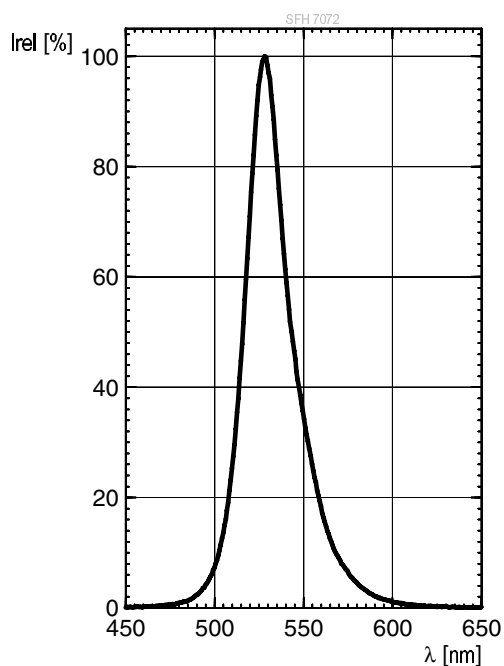

### Relative Spectral Emission <sup>1), 2)</sup>

- hyper red:  $I_{e,rel} = f(\lambda)$ ;  $I_F = 20 \text{ mA}$ ;  $t_p = 20 \text{ ms}$

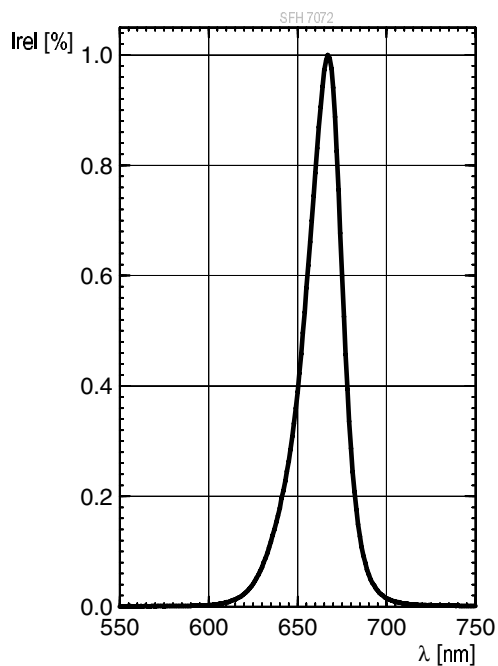

## Relative Spectral Emission <sup>1), 2)</sup>

- infrared (940 nm):  $I_{e,rel} = f(\lambda)$ ;  $I_F = 20 \text{ mA}$ ;  $t_p = 20 \text{ ms}$

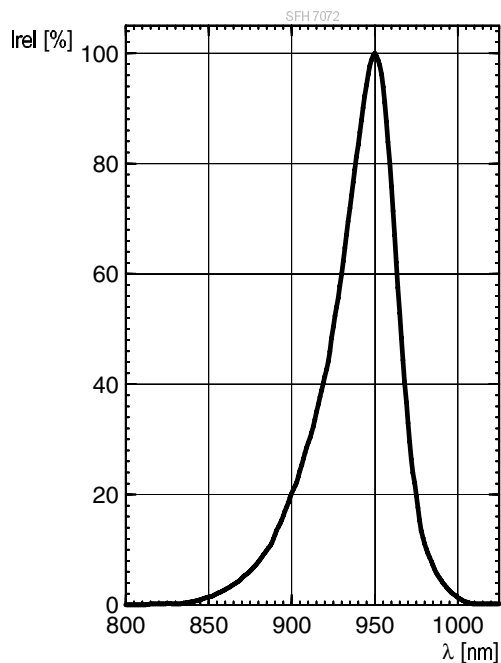

## Radiation Characteristics <sup>1), 2)</sup>

- true green/ hyper red/ infrared:  $I_{e,rel} = f(\varphi)$

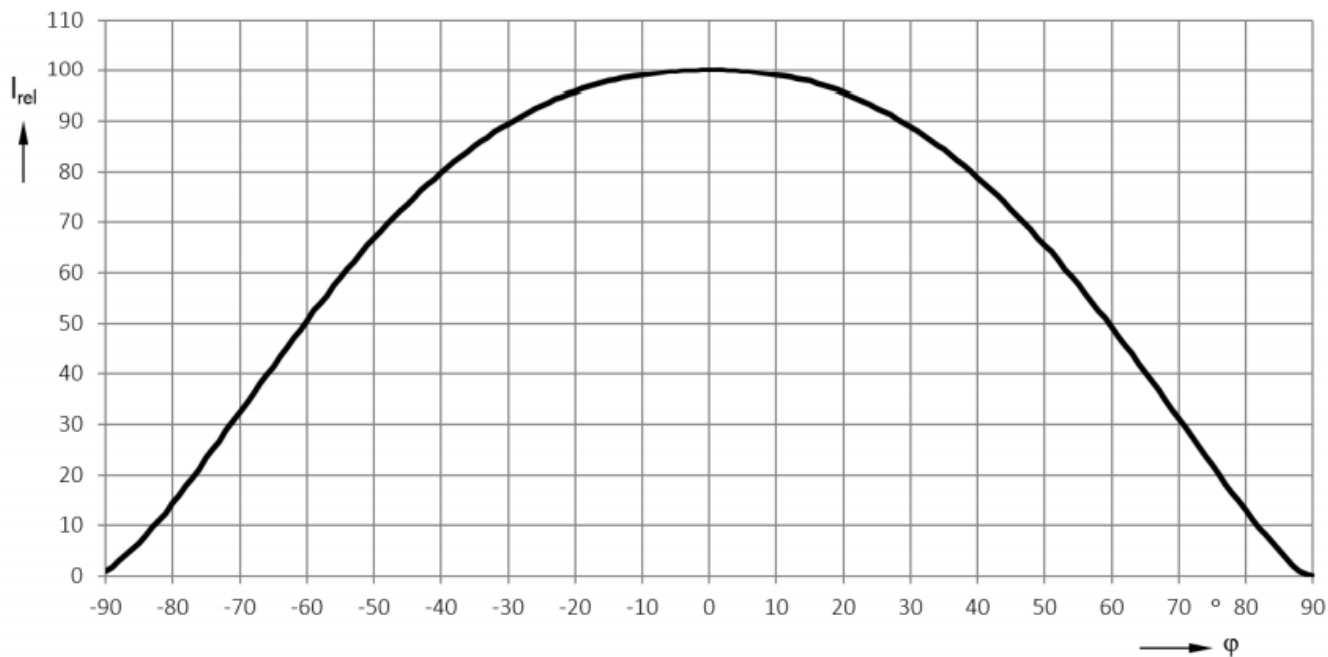

## Relative Spectral Sensitivity <sup>1), 2)</sup>

- photodiode BB:  $S_{rel} = f(\lambda)$

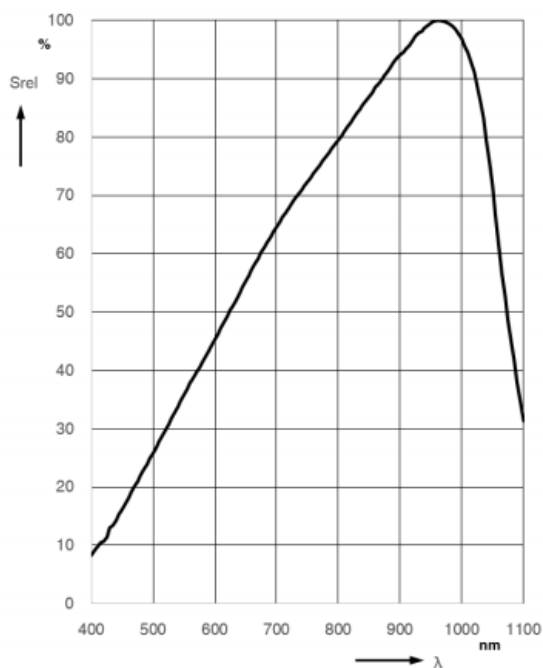

## Relative Spectral Sensitivity <sup>1), 2)</sup>

- photodiode IR-Cut:  $S_{rel} = f(\lambda)$

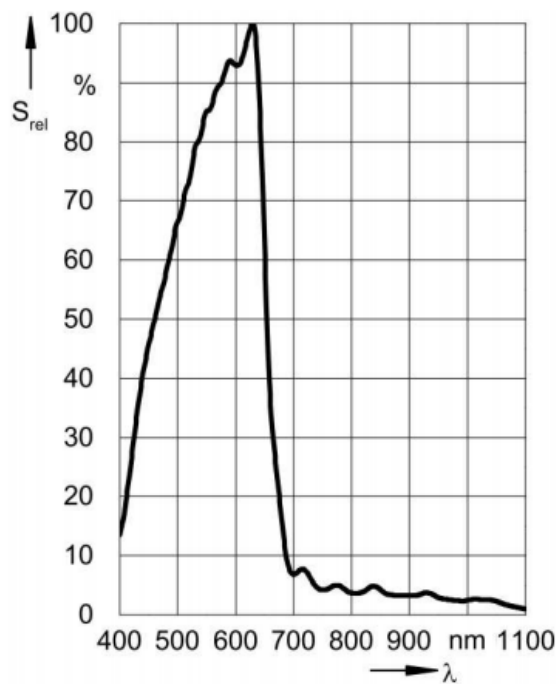

**Directional Characteristics** 1), 2)

photodiode broadband/ IR-cut:  $S_{rel} = f(\varphi)$ ;  $\lambda = 530 \text{ nm}$

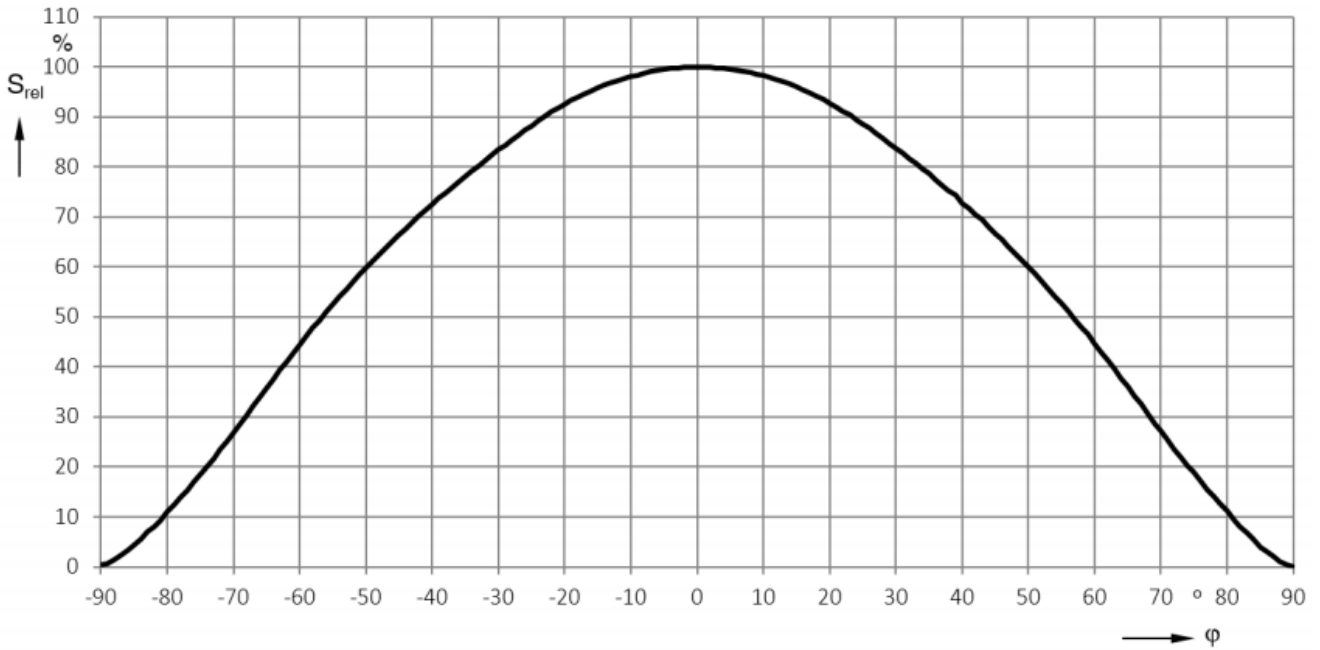

**Forward current** 1), 2)

• true green:  $I_F = f(V_F)$ ; single pulse;  $t_p = 100 \mu\text{s}$

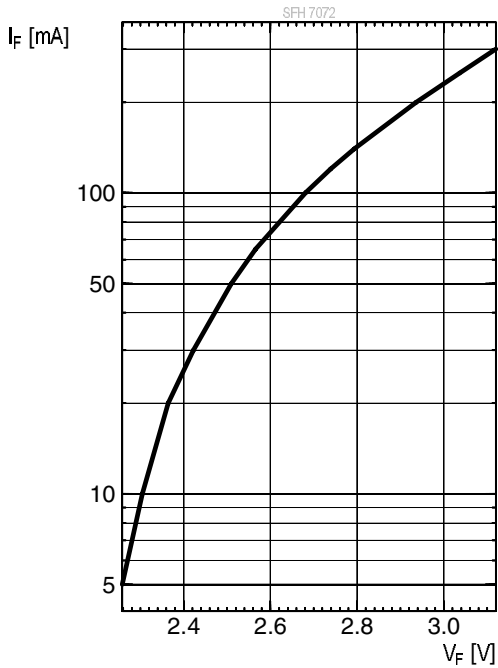

**Forward current** 1), 2)

• hyper red:  $I_F = f(V_F)$ ; single pulse;  $t_p = 100 \mu\text{s}$

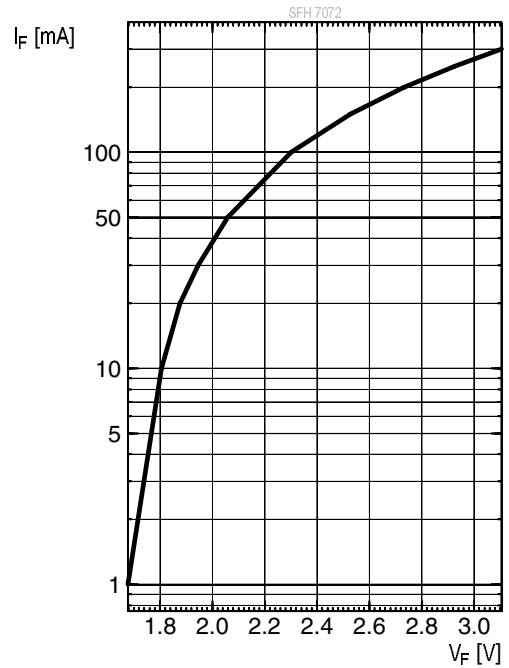

**Forward current** 1), 2)

- infrared (940 nm):  $I_F = f(V_F)$ ; s.p.;  $t_p = 100 \mu s$

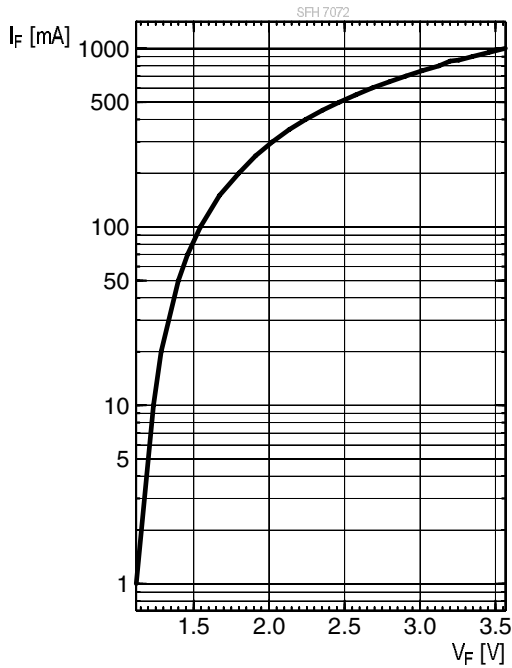

**Relative Total Radiant Flux** 1), 2)

- true green:  $\Phi_e / \Phi_e(20mA) = f(I_F)$ ; single pulse;  $t_p = 100 \mu s$

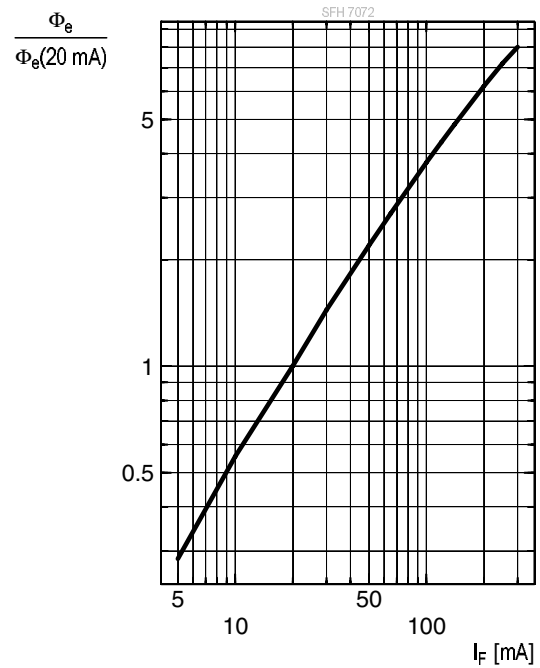

**Relative Total Radiant Flux** 1), 2)

- hyper red:  $\Phi_e / \Phi_e(20mA) = f(I_F)$ ; single pulse;  $t_p = 25 \mu s$
- infrared (940 nm):  $\Phi_e / \Phi_e(20mA) = f(I_F)$ ; s. p.;  $t_p = 25 \mu s$

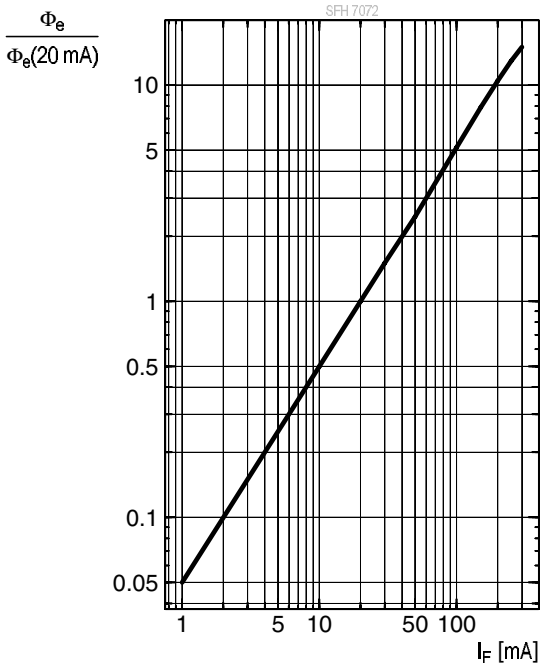

**Relative Total Radiant Flux** 1), 2)

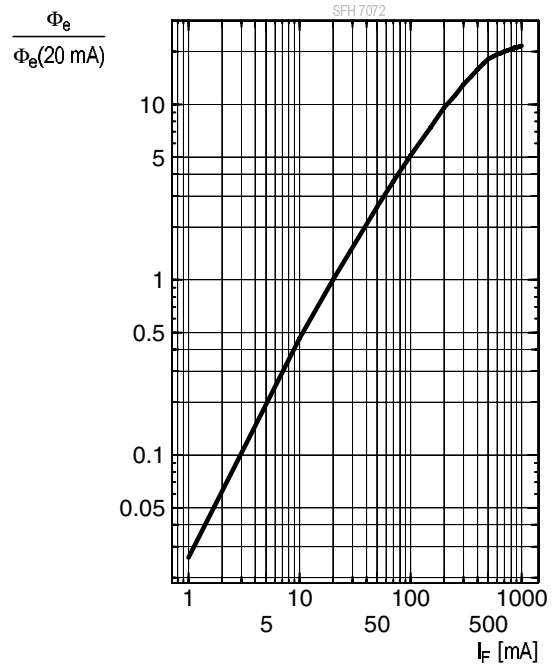

**Photocurrent** 1), 2)

■ photodiode BB:  $I_p = f(E_e)$ ;  $\lambda = \text{parameter}$ ;  $V_R = 5 \text{ V}$

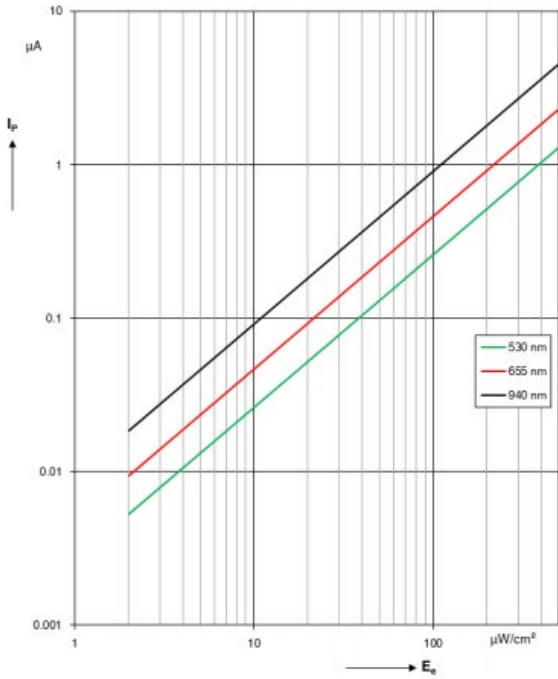

**Photocurrent** 1), 2)

■ photodiode IR-Cut:  $I_p = f(E_e)$ ;  $\lambda = 530 \text{ nm}$ ;  $V_R = 5 \text{ V}$

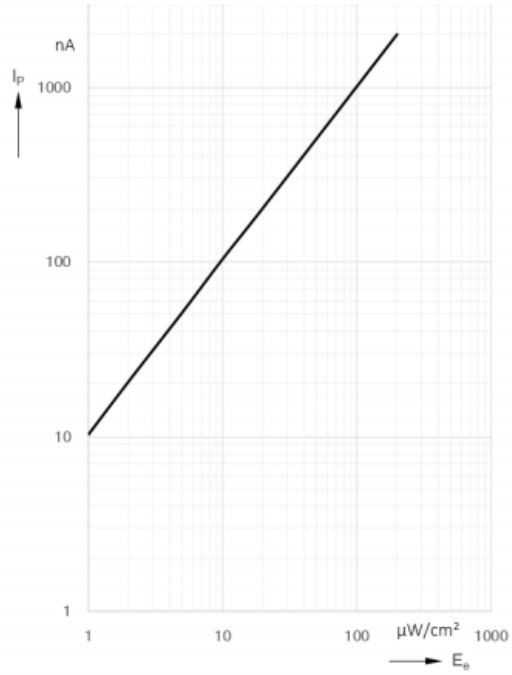

**Dark Current** 1), 2)

■ photodiode BB:  $I_R = f(V_R)$ ;  $E = 0$

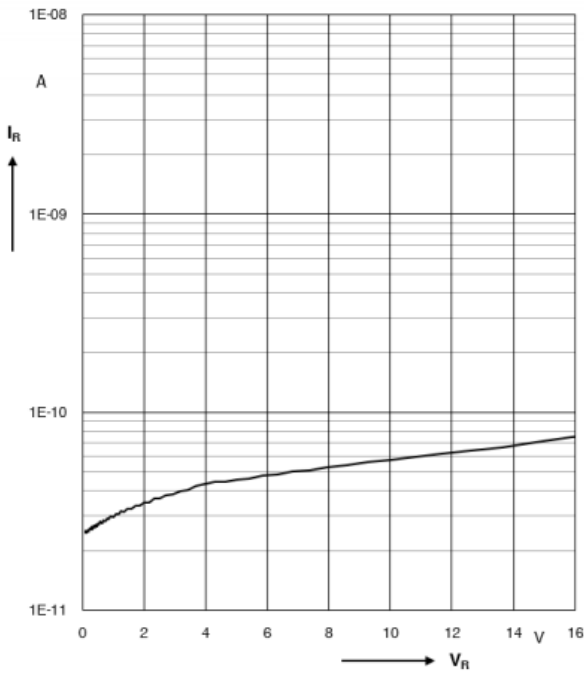

**Dark Current** 1), 2)

■ photodiode IR-Cut:  $I_R = f(V_R)$ ;  $E = 0$

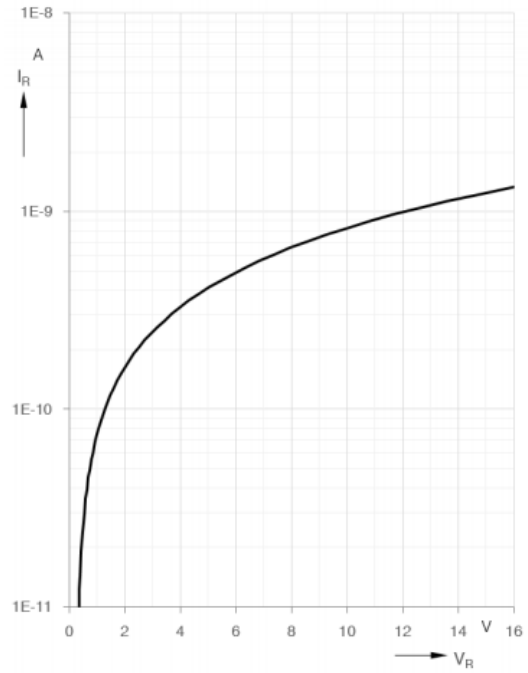

**Capacitance** 1), 2)

- photodiode BB:  $C = f(V_R)$ ;  $f = 1\text{MHz}$ ;  $E = 0$

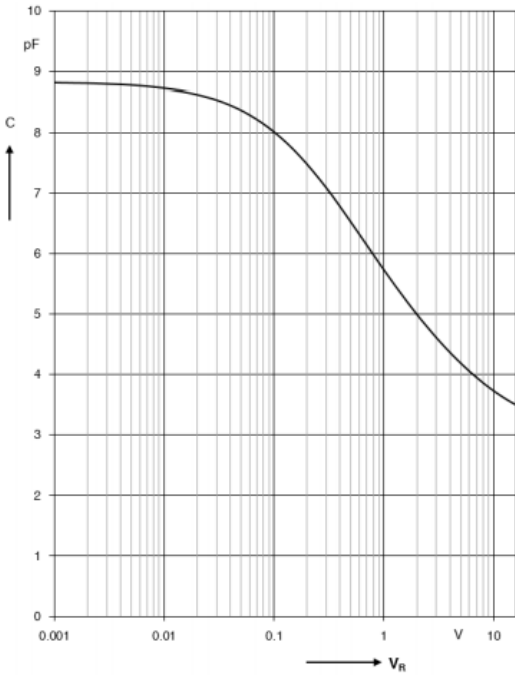

**Capacitance** 1), 2)

- photodiode IR-Cut:  $C = f(V_R)$ ;  $f = 1\text{MHz}$ ;  $E = 0$

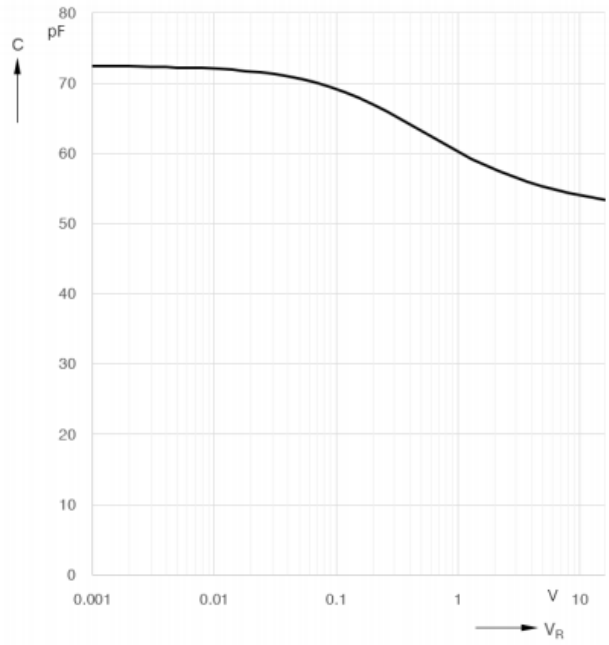

**Max. Permissible Forward Current**

- infrared (940 nm):  $I_{F,max} = f(T_A)$

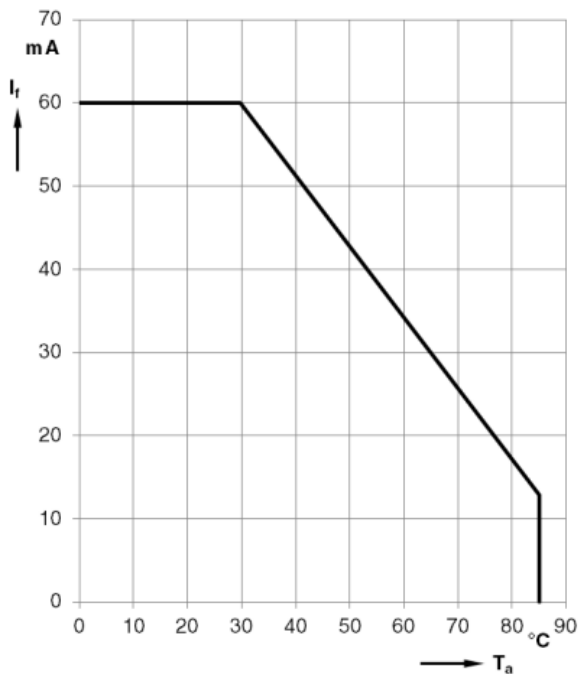

**Permissible Pulse Handling Capability**

- infrared (940 nm):  $I_F = f(t_p)$ ;  $D = \text{parameter}$ ;  $T_A = 25^\circ\text{C}$

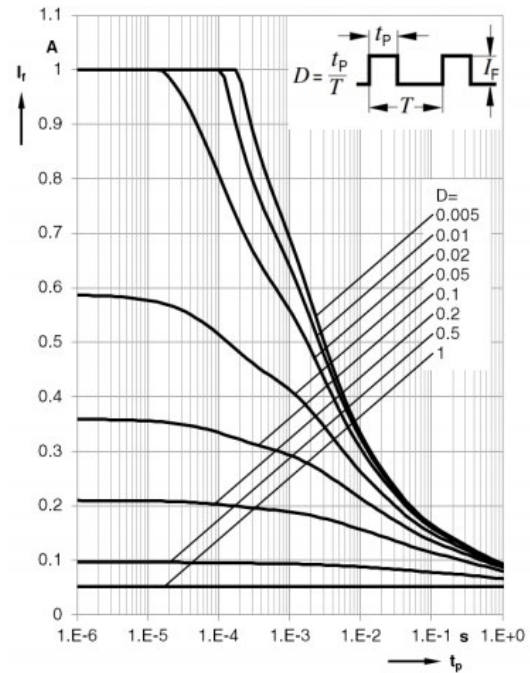



## Permissible Pulse Handling Capability

- infrared (940 nm):  $I_F = f(t_p)$ ;  $D = \text{parameter}$ ;  $T_A = 85^\circ\text{C}$

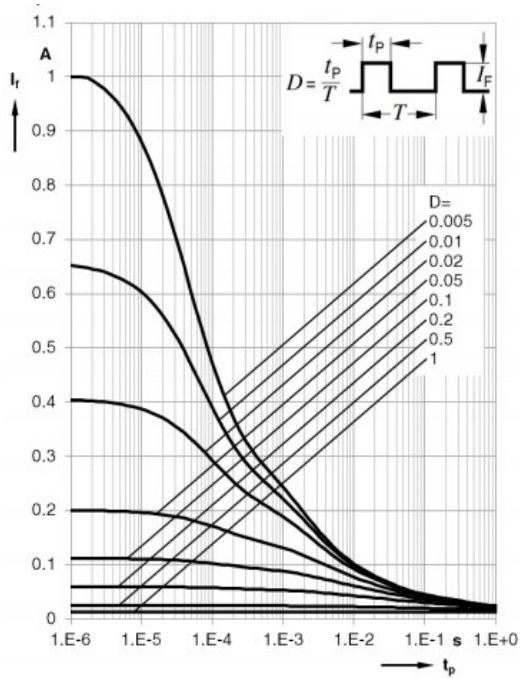

## Dimensional Drawing <sup>3)</sup>

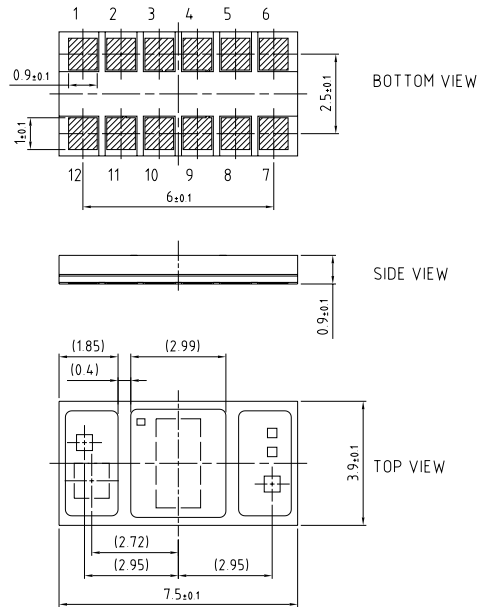

C63062-A4325-A1.-01

## Further Information:

**Approximate Weight:** 44.0 mg

Pin	Description
1	PD1 (BB) Cathode
2	PD1 (BB) Anode
3	PD2 (IR-Cut) Cathode
4	IR LED Anode
5	Green 1 LED Anode
6	Green 1 LED Cathode
7	Red LED Anode
8	Red LED Cathode
9	IR LED Cathode
10	PD2 (IR-Cut) Anode
11	Green 2 LED Anode
12	Green 2 LED Cathode

### Recommended Solder Pad <sup>3)</sup>

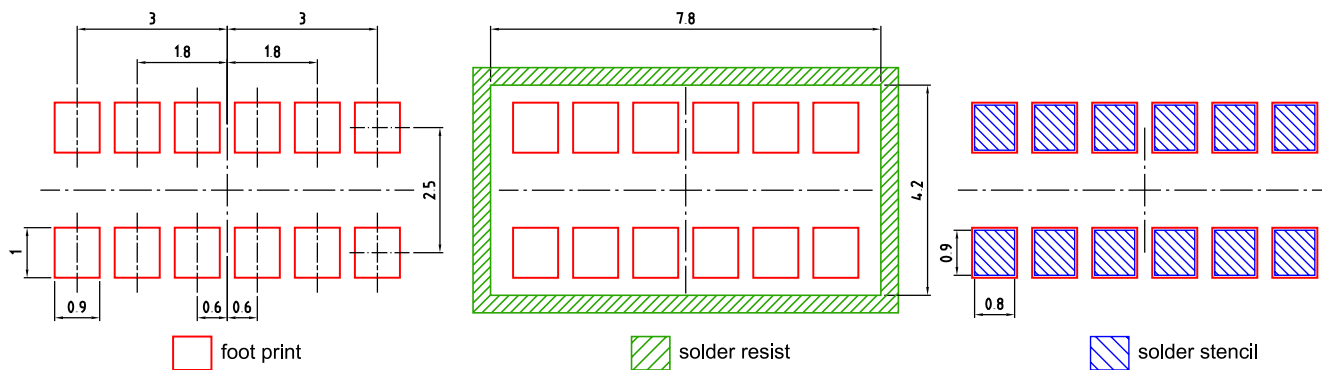

Component Location on Pad

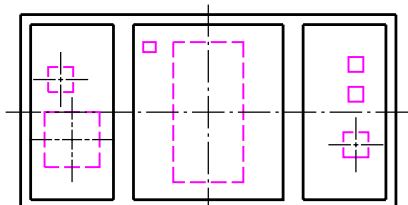

E062.3010.217-01

## Reflow Soldering Profile

Product complies to MSL Level 4 acc. to JEDEC J-STD-020E

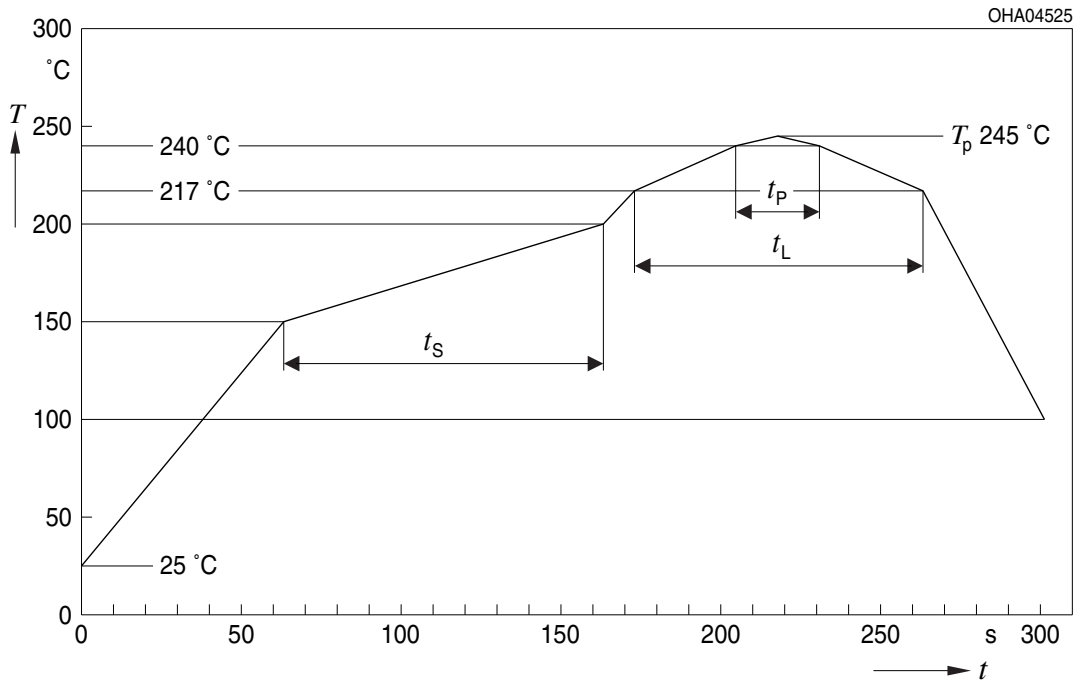

Profile Feature	Symbol	Pb-Free (SnAgCu) Assembly			Unit
		Minimum	Recommendation	Maximum	
Ramp-up rate to preheat <sup>*)</sup> 25 °C to 150 °C			2	3	K/s
Time $t_s$ $T_{Smin}$ to $T_{Smax}$	$t_s$	60	100	120	s
Ramp-up rate to peak <sup>*)</sup> $T_{Smax}$ to $T_p$			2	3	K/s
Liquidus temperature	$T_L$		217		°C
Time above liquidus temperature	$t_L$		80	100	s
Peak temperature	$T_p$		245	260	°C
Time within 5 °C of the specified peak temperature $T_p - 5$ K	$t_p$	10	20	30	s
Ramp-down rate* $T_p$ to 100 °C			3	6	K/s
Time 25 °C to $T_p$				480	s

All temperatures refer to the center of the package, measured on the top of the component

\* slope calculation  $DT/Dt$ :  $Dt$  max. 5 s; fulfillment for the whole T-range

Taping <sup>3)</sup>

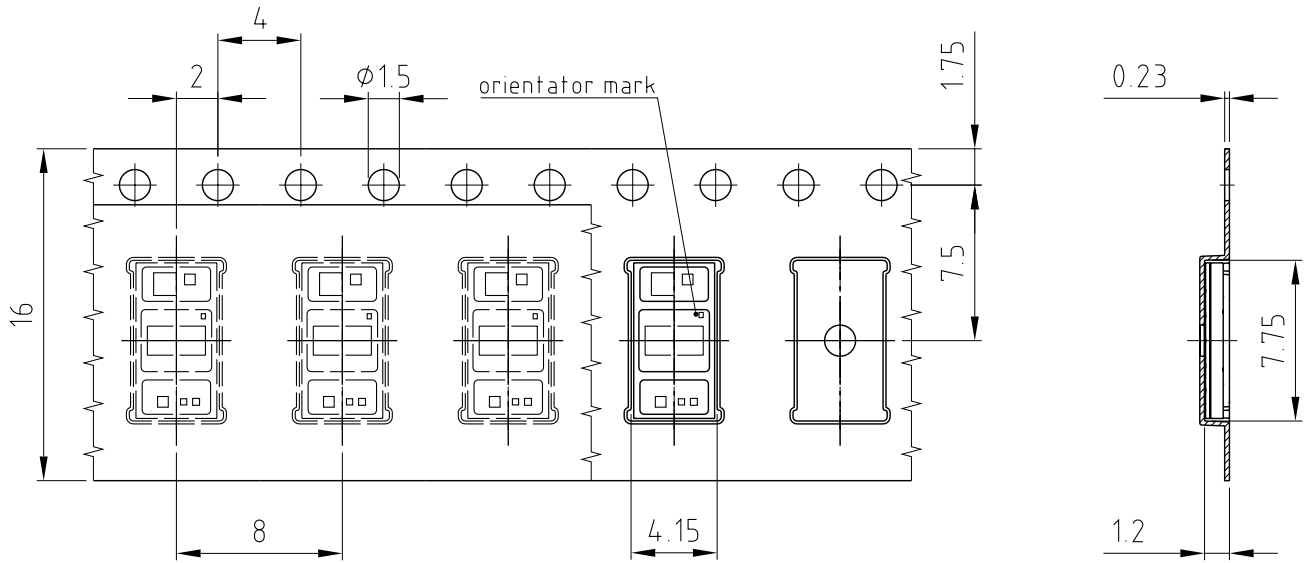

C63062-A4325-B2 -02

## Tape and Reel <sup>4)</sup>

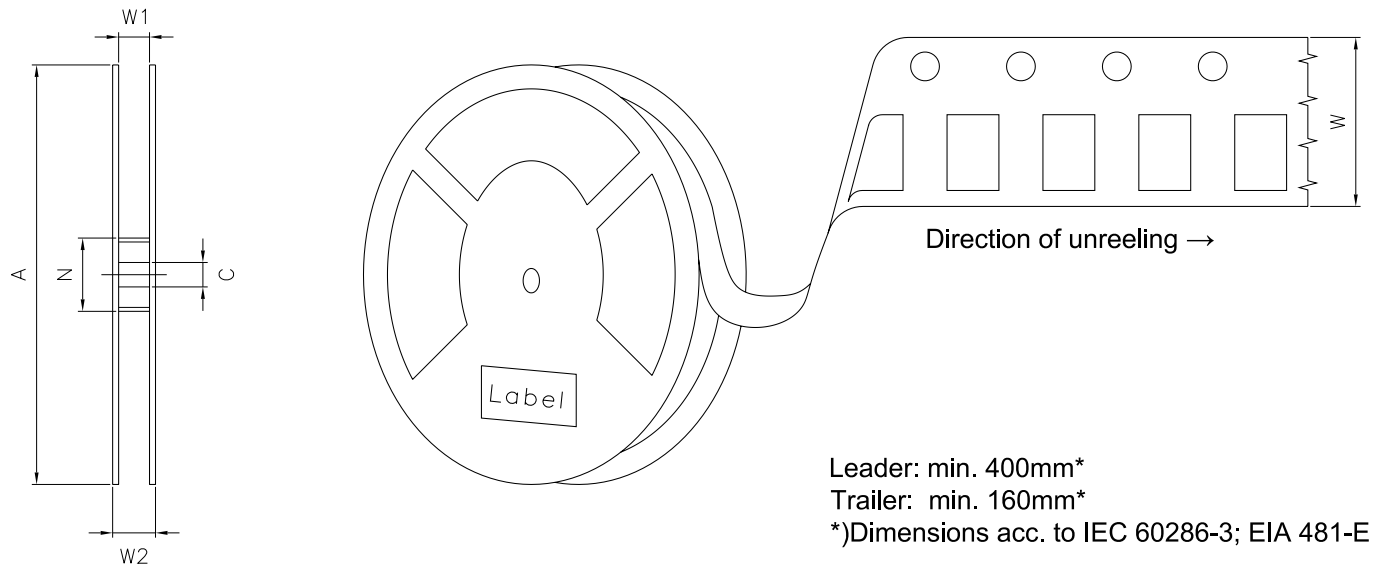

## Reel Dimensions

A	W	N <sub>min</sub>	W <sub>1</sub>	W <sub>2 max</sub>	Pieces per PU
180 mm	16 + 0.3 / - 0.1 mm	60/100 mm	16.4 + 2 mm	22.4 mm	1500

**Barcode-Product-Label (BPL)**

**OSRAM Opto Semiconductors** LX XXXX    BIN1: XX-XX-X-XXX-X

RoHS Compliant

(6P) BATCH NO: 1234567890 ML Temp    ST  
X    XXX °C X

(1T) LOT NO: 1234567890 (9D) D/C: 1234

Pack: RXX  
DEMY    XXX  
X\_X123\_1234.1234 X

(X) PROD NO: 123456789(Q)QTY: 9999 (G) GROUP: XX-XX-X-X

OHA04563

**Dry Packing Process and Materials** <sup>3)</sup>

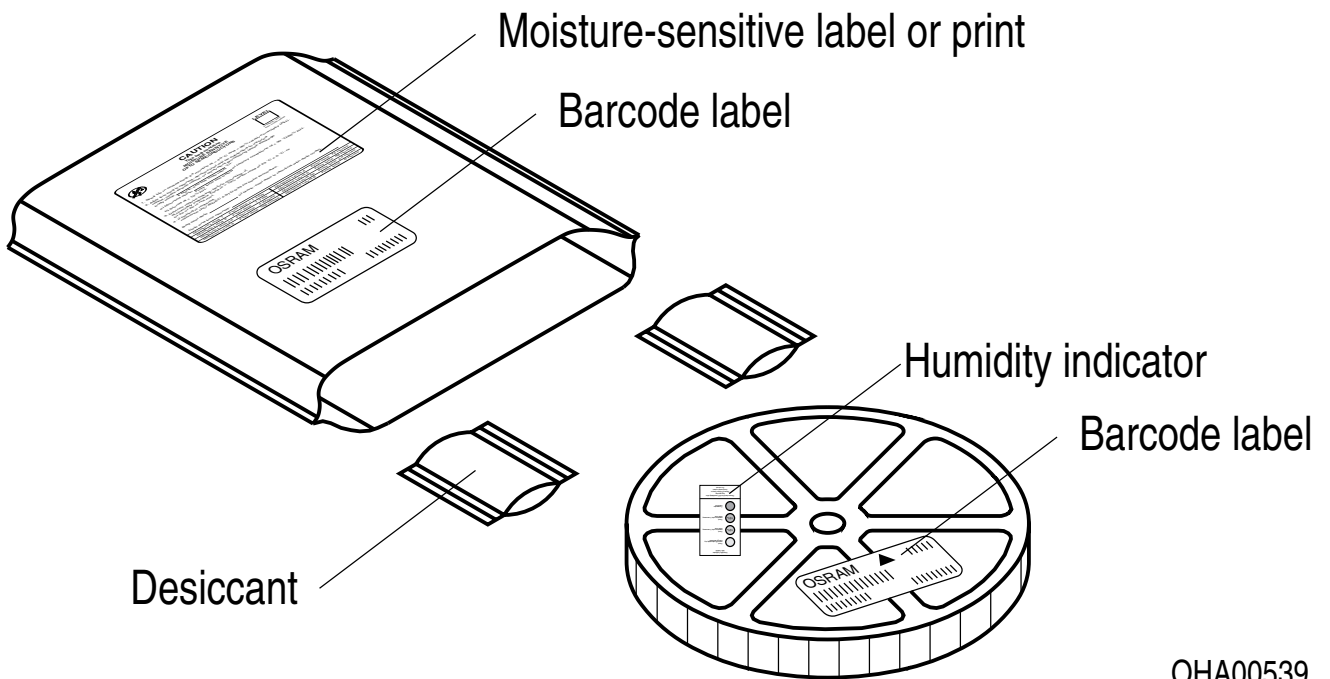

OHA00539

Moisture-sensitive product is packed in a dry bag containing desiccant and a humidity card according JEDEC-STD-033.

## Disclaimer

### Attention please!

The information describes the type of component and shall not be considered as assured characteristics. Terms of delivery and rights to change design reserved. Due to technical requirements components may contain dangerous substances.

For information on the types in question please contact our Sales Organization.

If printed or downloaded, please find the latest version on our website.

### Packing

Please use the recycling operators known to you. We can also help you – get in touch with your nearest sales office. By agreement we will take packing material back, if it is sorted. You must bear the costs of transport. For packing material that is returned to us unsorted or which we are not obliged to accept, we shall have to invoice you for any costs incurred.

### Product and functional safety devices/applications or medical devices/applications

Our components are not developed, constructed or tested for the application as safety relevant component or for the application in medical devices.

Our products are not qualified at module and system level for such application.

In case buyer – or customer supplied by buyer – considers using our components in product safety devices/ applications or medical devices/applications, buyer and/or customer has to inform our local sales partner immediately and we and buyer and /or customer will analyze and coordinate the customer-specific request between us and buyer and/or customer.



---

## Glossary

- 1) **Typical Values:** Due to the special conditions of the manufacturing processes of semiconductor devices, the typical data or calculated correlations of technical parameters can only reflect statistical figures. These do not necessarily correspond to the actual parameters of each single product, which could differ from the typical data and calculated correlations or the typical characteristic line. If requested, e.g. because of technical improvements, these typ. data will be changed without any further notice.
- 2) **Testing temperature:**  $T_A = 25^\circ\text{C}$  (unless otherwise specified)
- 3) **Tolerance of Measure:** Unless otherwise noted in drawing, tolerances are specified with  $\pm 0.1$  and dimensions are specified in mm.
- 4) **Tape and Reel:** All dimensions and tolerances are specified acc. IEC 60286-3 and specified in mm.
- 5) **Reverse Operation:** This product is intended to be operated applying a forward current within the specified range. Applying any continuous reverse bias or forward bias below the voltage range of light emission shall be avoided because it may cause migration which can change the electro-optical characteristics or damage the LED.
- 6) **Wavelength:** The wavelengths are measured with a tolerance of  $\pm 1$  nm.
- 7) **Forward Voltage:** The forward voltages are measured with a tolerance of  $\pm 0.1$  V.
- 8) **Brightness:** The brightness values are measured with a tolerance of  $\pm 11\%$ .
- 9) **Photocurrent:** The photocurrent values are measured (by irradiating the devices with a homogenous light source and applying a voltage to the device) with a tolerance of  $\pm 11\%$ .

---

## Revision History

Version	Date	Change
1.1	2019-04-24	Characteristics
1.2	2020-07-10	Derating (Diagrams) Schematic Transportation Box Dimensions of Transportation Box
1.3	2021-04-27	Characteristics New Layout
1.4	2021-08-12	Features
1.5	2022-05-10	Characteristics Electro - Optical Characteristics (Diagrams) New Layout

---



EU RoHS and China RoHS compliant product

此产品符合欧盟 RoHS 指令的要求；  
按照中国的相关法规和标准，  
不含有毒有害物质或元素。

**Published by ams-OSRAM AG**

Tobelbader Strasse 30, 8141 Premstaetten, Austria

Phone +43 3136 500-0

[ams-osram.com](http://ams-osram.com)

© All rights reserved

**am** 

**OSRAM**